

- Electric supply connection:
AC 400V; 50HZ; 6,5kW; 15A
3PH + PE
- Compressed air supply:
Ø10mm-3/8"
- Flocculant station inlet:
Ø19mm-Ø3/4"
Use pure water only.
- Flocculant station discharge:
Ø19mm-Ø3/4"
- Water connection for cloths washing system:
Ø60mm-2.4in
To be connected to the stone-processing machines' water supply

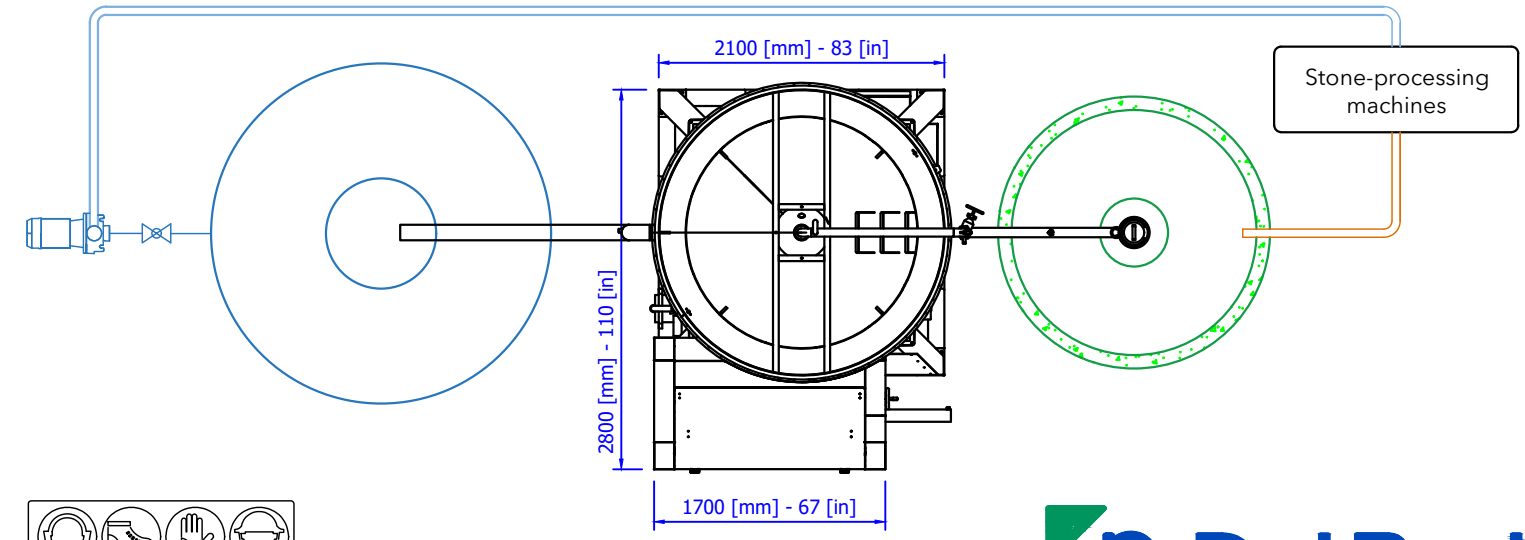

MACCHINA TIPO:
MACHINE TYPE:
Water clarification and sludge dehydration plant
MINI COMPACT L 3.1 750L
Serial Number: _____
CLIENTE:
CUSTOMER: _____

LAY-OUT DI MASSIMA
(plant lay-out)
CODICE DISEGNO
(drawing code) _____
DATA
(date) _____
APPROVATO
(approved) _____

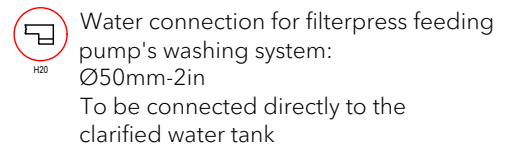
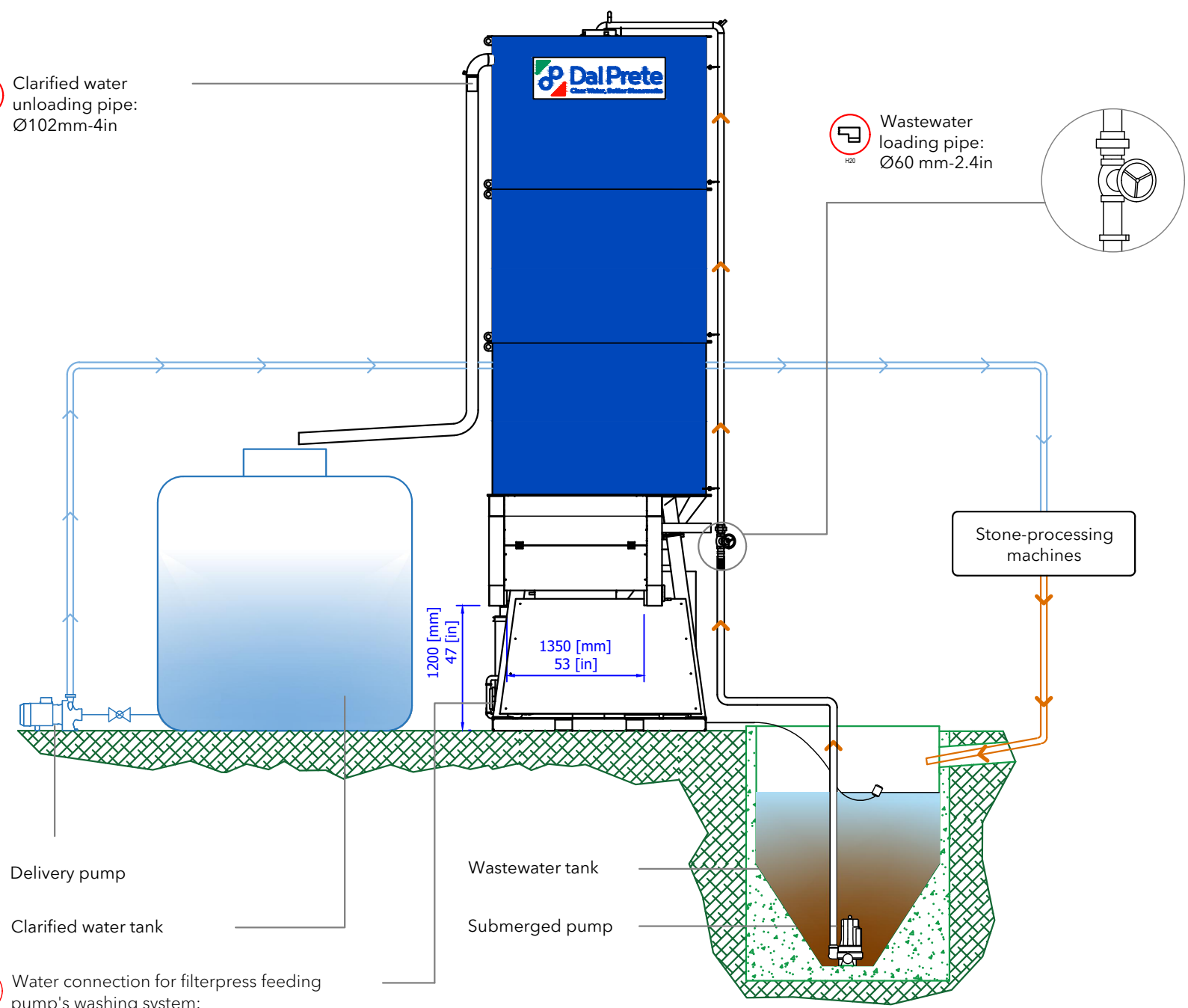
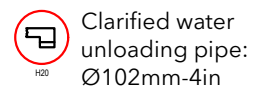